

VELAN

KNIFE GATE VALVES



2-36" (50-900 mm) • All Stainless Steel

MANUFACTURING PLANTS AROUND THE WORLD

PLANT 1



MONTREAL, CANADA 109,000 sq. ft. (10,126 m²) ¼–4" (8–100 mm) forged gate, globe & check valves, ASME 'N' stamp, ISO 9001:2000

PLANT 2 & 7



MONTREAL, CANADA 170,000 sq. ft. (15,800 m²) 2–60" (50–1500 mm) forged and cast steel gate, globe, check, ball, knife and butterfly valves 3–36" (80–700 mm) ASME 'N' stamp, ISO 9001:2000

PLANT 4 & 6



GRANBY, CANADA 186,500 sq. ft. (17,325 m²) 2–12" (50–300 mm) cast steel gate and check valves, ¼–12" (8–300 mm) ball valves, ISO 9001:2000



TORONTO, CANADA Velan-Proquip 41,000 sq. ft. (3,800 m²) 2–48" (50–1200 mm) wafer check valves ½–24" (15–600 mm) clamp joint connectors, ISO 9001:2000



WILLICH, GERMANY 12,000 sq. ft. (1,115 m²) ISO 9002



LEICESTER, ENGLAND 14,000 sq. ft. (1,300 m²) Steam traps, ¾–2" (10–50 mm) bonnetless globe valves, ISO 9001



LISBON, PORTUGAL 60,000 sq. ft. (5,600 m²) 2–12" (50–300 mm) cast steel gate, globe and check valves, ISO 9002

PLANT 3



WILLISTON, VERMONT, U.S.A. 155,000 sq. ft. (14,400 m²) 2–24" (50–600 mm) forged and cast steel gate, globe and check valves, ASME 'N' stamp, ISO 9001:2000



LYON, FRANCE 160,000 sq. ft. (14,900 m²) ¼–40" (8–1,000 mm) forged and cast steel gate, globe and butterfly valves, ISO 9001



MEZZAGO, ITALY 40,000 sq. ft. (3,700 m²) 1–64" (25–1600 mm) API 6A & 6D trunnion mounted ball valves, ISO 9001:2000



ANSAN CITY, SOUTH KOREA Plant 1 30,000 sq. ft. (2,800 m²) components and 2–4" (50–100 mm) cast steel valves, ISO 9002



ANSAN CITY, SOUTH KOREA Plant 2 65,000 sq. ft. (5,800 m²) 2–12" (50–300 mm) cast steel gate, globe, check, ball and knife gate valves, ISO 9002



TAICHUNG, TAIWAN Velan-Valvac 20,000 sq. ft. (1,840 m²) ¼–2" (8–50 mm) ball valves, ISO 9002

STANDARD KNIFE GATE VALVE DESIGN FEATURES

ADVANTAGES OVER FABRICATED VALVES

- Cast stainless steel body and investment cast yoke. In fabricated valves, leakage of corrosive medium due to neglected maintenance on the packing, or line pressure surges causes corrosion and failure of most carbon steel or cast iron components.
- An all stainless steel valve offers better corrosion resistance than cast iron lined valves. The total cost of ownership becomes more attractive than the initial savings.:

FIRST ALL STAINLESS STEEL KNIFE GATE VALVE

- **Rugged one-piece body** including flanges. Cast in stainless steel to eliminate corrosion problems that are found with cast iron, or steel valves lined with stainless steel.
- **All stainless steel investment cast yoke.** Up to 12".
- **Investment cast stainless steel packing flange** the space between the blade and the packing flange is very small and critical on smaller size valves. For 2 – 8" Velan Knife Gate Valves feature high precision investment cast packing flanges for a tight "contact-free" fit.

THICKER KNIFE GATE

- **Thicker knife gate** to eliminate distortion under maximum differential pressure and to provide tight seating (see page 12).
- **Precision ground blade** on both sides for tighter packing chamber sealing. Sealing face of the gate is lapped to provide the best possible seat tightness.
- **Precision machined beveled gate end** provides long life of seating components.
- **Gate guides and lugs.** 180° guiding for the moving gate, while jamba at the bottom hold the knife gate to assure proper seating.
- **Integral locking device.**

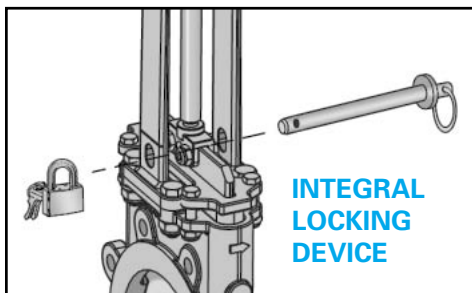

RAISED FACE SEAT

- The groove around the seat permits the gate to push particles aside and prevents clogging. When the valve is open the flow cleans the groove.
- **Lapped seat** ensures tight closure.

RELIABLE PACKING CHAMBER

- Smooth and uniform chamber.
- Gate ground on both sides.
- Equally distributed gland bolts provide uniform compression of packing.
- Gland bolts easily accessible.

ALL NUTS SELF-LOCKING

LOW TORQUE STEM DRIVE ASSEMBLY

- Ni-resist or bronze thrust bearing to prevent seizure of handwheel hub, 2 – 12" valves.
- **Needle thrust bearings,** 14 – 36" valves.
- **Larger more comfortable malleable iron handwheel** for easier operation.
- Grease fitting.
- Acid resistant Ni-resist or bronze stem nut.

FACTORY TESTING

- **Each valve is pressure tested** for seat tightness, shell and packing integrity including cycling tests to check for reliability of operation.



* For options see page 10.



ALL STAINLESS STEEL STANDARD KNIFE GATE VALVES
WAFER-TYPE, METAL SEAT, 2–36" (50–900 mm)
 FULLY LUGGED, TYPE 310C TO TAPPI TIS 405-8, LARGE PORT



PART	STANDARD MATERIALS	
Body ⁽¹⁾	CF8M (SS 316)	CG3M (317L)
Knife	SS 316	SS 317L
Yoke	CF8	
Stem ⁽¹⁾	SS 316 or SS 304	
Packing flange	CF8 (SS 304)	
Stem nut	Ni-resist or Bronze	
Bolt	SS 304	
Nut	SS 304 self-locking	
Packing	Graphite & PTFE-impregnated synthetic yarn (ph: 0-14)	
Thrust bearing	Steel, 14" - 36"	
Handwheel	Malleable iron	
Handwheel nut	Malleable iron, zinc plated	

(1) Other materials available (see page 17).

DESIGN FEATURES:

- Designed to handle slurries, pulp stock and corrosive fluids in process industries.
- Meets TAPPI standard TIS 405-8 and MSS SP-81 for wafer-type knife gate valves.
- Flanges match ASME B16.5 Class 150. Holes tapped.
- 150 psig (10.3 bar) max. working pressure. 150°F (65°C) max. working temperature. Applications outside of these conditions require special design considerations.
- Factory installed V-port seat insert available for metering or throttling service (page 10).
- These high quality metal-seated knife gate valves with ground knife gates and lapped seating faces have maximum leakage rate 4-10 times less than the permissible rates shown in TAPPI 405-8 & MSS SP-81.
- Needle bearings on 14–36" valves.
- Available with lever, chain, gear, electric, air or hydraulic actuation (see page 14).

DIMENSIONS AND WEIGHTS

SIZE in mm	A	C	BD	Tap size in (UNC)	No. of Holes	D	D1	E	Knife	O	V-Port Area in ² /cm ²	lb kg
2 50	1.88 48	3.63 92	4.75 121	0.63-11	4	9.94 252	12.06 306	6.38 162	0.25 6.0	1.84 47	1.93 12	12 5
3 80	2.00 51	5.00 127	6.00 152	0.63-11	4	12.19 310	15.32 389	8.00 203	0.25 6.0	2.84 72	4.60 3	21 9
4 100	2.00 51	6.19 157	7.50 191	0.63-11	8	14.51 369	18.60 472	8.00 203	0.25 6.0	3.72 94	7.87 51	28 13
6 150	2.25 57	8.50 216	9.50 241	0.75-10	8	18.31 465	24.38 619	10.00 254	0.35 9.0	5.58 142	17.70 114	48 22
8 200	2.75 70	10.63 270	11.75 298	0.75-10	8	22.66 576	30.66 779	14.00 356	0.48 12.1	7.58 193	32.66 211	77 35
10 250	2.75 70	12.75 324	14.25 362	0.88-9	12	27.19 691	37.19 945	14.00 356	0.48 12.1	9.31 236	49.32 318	111 50
12 300	3.00 76	15.00 381	17.00 432	0.88-9	12	31.25 794	43.25 1099	18.00 457	0.60 15.0	11.31 287	72.78 470	156 71
14 350	3.00 76	16.75 425	18.75 476	1.00-8	12	35.32 897	48.69 1237	20.00 508	0.60 15.0	12.81 325	93.36 602	231 105
16 400	3.50 89	19.38 492	21.25 540	1.00-8	16	39.01 991	55.13 1400	20.00 508	0.69 18.0	14.81 376	124.79 805	289 135
18 450	3.50 89	21.00 533	22.75 578	1.12-7	16	46.58 1183	64.31 1633	24.00 610	0.83 21.0	17.25 438	169.23 1092	452 205
20 500	4.50 114	23.00 584	25.00 635	1.12-7	20	51.31 1303	71.31 1811	24.00 610	0.94 24.0	19.25 489	210.75 1360	583 265
24 600	4.50 114	27.25 692	29.50 749	1.25-7	20	58.69 1491	81.94 2081	24.00 610	1.06 27.0	22.88 581	297.60 1920	784 356
30 750	5.50 140	33.75 857	36.00 914	1.25-7	14 ⁽²⁾	72.50 1842	101.63 2581	(1)	1.18 30.0	28.75 730	470.09 3033	1300 590
36 900	6.00 152	40.25 1022	42.75 1086	1.50-6	16 ⁽²⁾	86.75 2203	121.75 3092	(1)	1.25 31.8	34.75 883	686.77 4431	1650 748

(1) Gear actuators. (2) Hole spacing meets MSS SP-44.

CV & SEAT TIGHTNESS

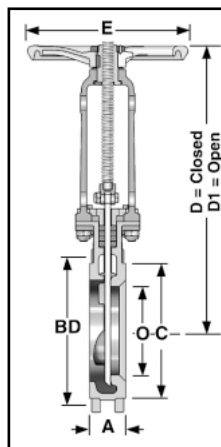

SIZE (in)	STANDARD CV ⁽¹⁾	V-PORT CV ⁽¹⁾	LEAKAGE ⁽²⁾ (cc/min.)	
			TAPPI ALLOW.	VELAN ACTUAL
2	340	85	80	0-20
3	850	195	120	0-20
4	1,500	340	160	0-40
6	3,500	800	240	0-60
8	6,600	1,400	320	0-80
10	9,800	1,900	400	0-100
12	15,300	2,850	480	0-100
14	19,000	3,750	560	0-100
16	25,500	4,900	640	0-100
18	36,000	6,500	720	0-100
20	45,000	8,000	800	0-100
24	60,000	12,000	960	0-100
30	95,000	19,000	1200	0-100
36	138,000	28,000	1440	0-100

(1) Tested in accordance with ASME/ISA-575-02.
 (2) Test pressure 40 psi water (TAPPI and MSS SP81).



ALL STAINLESS STEEL STANDARD KNIFE GATE VALVES
WAFER-TYPE, RESILIENT SEAT, 2–36" (50–900 mm)
 FULLY LUGGED, TYPE 320C TO TAPPI TIS 405-8, LARGE PORT



PART	STANDARD MATERIALS	
Body ⁽¹⁾	CF8M (SS 316)	CG3M (317L)
Knife	SS 316	SS 317L
Seat ring	SS 316	SS 317L
O-ring	PTFE (standard), viton, neoprene, polyurethane, EPDM	
Yoke	CF8	
Stem ⁽¹⁾	SS 316 or SS 304	
Packing flange	CF8 (SS 304)	
Stem nut	Ni-resist or Bronze	
Bolt	SS 304	
Nut	SS 304 self-locking	
Packing	Graphite & PTFE-impregnated synthetic yarn (ph: 0-14)	
Thrust bearing	Steel, 14" - 36"	
Handwheel	Malleable iron	
Handwheel nut	Malleable iron, zinc plated	

(1) Other materials available (see page 17).

DESIGN FEATURES:

- Designed to handle slurries, pulp stock and corrosive fluids in process industries where applications call for resilient seat with zero leakage to 150 psi (10.3 bar) in main direction and limited tightness in opposite direction, at low pressure.
- Replaceable, resilient crimped seat rings.
- Meets TAPPI standard TIS 405-8 and MSS SP-81 for wafer-type knife gate valves.
- Replaceable seat extends the service life of the valve. Resilient seats can be easily replaced after removing valve from the line (Details on page 12).
- For highly abrasive applications we can supply a replaceable seat ring with a hardfaced knife surface.
- Non-clogging large port.
- 150 psig (10.3 bar) max. working pressure. 150°F (65°C) max. working temperature. Applications outside of these conditions require special design considerations.
- Needle bearings on 14"-36" valves.
- Available with lever, chain, gear, electric, air or hydraulic actuation (see page 14).

DIMENSIONS AND WEIGHTS

SIZE in mm	A	C	BD	Tap size in (UNC)	No. of Holes	D	D1	E	Knife	O	lb kg
2 50	1.88 48	3.63 92	4.75 121	0.63-11	4	9.94 252	12.06 306	6.38 162	0.25 6.0	1.84 47	12 5
3 80	2.00 51	5.00 127	6.00 152	0.63-11	4	12.19 310	15.32 389	8.00 203	0.25 6.0	2.84 72	21 9
4 100	2.00 51	6.19 157	7.50 191	0.63-11	8	14.51 369	18.60 472	8.00 203	0.25 6.0	3.72 94	28 13
6 150	2.25 57	8.50 216	9.50 241	0.75-10	8	18.31 465	24.38 619	10.00 254	0.35 9.0	5.56 141	48 22
8 200	2.75 70	10.63 270	11.75 298	0.75-10	8	22.66 576	30.66 779	14.00 356	0.48 12.1	7.56 192	77 35
10 250	2.75 70	12.75 324	14.25 362	0.88-9	12	27.19 691	37.19 945	14.00 356	0.48 12.1	9.31 236	111 50
12 300	3.00 76	15.00 381	17.00 432	0.88-9	12	31.25 794	43.25 1099	18.00 457	0.60 15.0	11.31 287	156 71
14 350	3.00 76	16.75 425	18.75 476	1.00-8	12	35.32 897	48.69 1237	20.00 508	0.60 15.0	12.81 325	231 105
16 400	3.50 89	19.38 492	21.25 540	1.00-8	16	39.01 991	55.13 1400	20.00 508	0.69 18.0	14.81 376	289 135
18 450	3.50 89	21.00 533	22.75 578	1.12-7	16	46.58 1183	64.31 1633	24.00 610	0.83 21.0	17.25 438	452 205
20 500	4.50 114	23.00 584	25.00 635	1.12-7	20	51.31 1303	71.31 1811	24.00 610	0.94 24.0	19.25 489	583 265
24 600	4.50 114	27.25 692	29.50 749	1.25-7	20	58.69 1491	81.94 2081	24.00 610	1.06 27.0	22.78 579	784 356
30 750	5.50 140	33.75 857	36.00 914	1.25-7	14 ⁽²⁾	72.50 1842	101.63 2581	(1)	1.18 30.0	28.25 718	1300 590
36 900	6.00 152	40.25 1022	42.75 1086	1.50-6	16 ⁽²⁾	86.75 2203	121.75 3092	(1)	1.25 31.8	34.25 870	1650 748

(1) Gear actuators. (2) Hole spacing meets MSS SP-44.

CV & SEAT TIGHTNESS

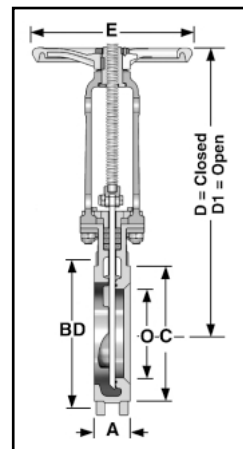

SIZE (in)	STANDARD CV ⁽¹⁾	LEAKAGE ⁽²⁾ (cc/min.)
		MAIN SEAT 1-150 PSI
2	340	0
3	850	0
4	1,500	0
6	3,500	0
8	6,600	0
10	9,800	0
12	15,300	0
14	19,000	0
16	25,500	0
18	36,000	0
20	45,000	0
24	60,000	0
30	95,000	0
36	138,000	0

(1) Tested in accordance with ASME/ISA-575-02.
 (2) Test pressure 40 psi (2.8 bar) water
 (TAPPI and MSS SP81).



**ALL STAINLESS STEEL STANDARD KNIFE GATE VALVES
FLANGED, RESILIENT OR METAL SEAT, 2–24" (50–600 mm)
TYPE 322C THROUGH-BOLTED FLANGES
ASME B16.5 CLASS 150, LARGE PORT**



**Resilient seat design shown
integral metal seats also available**

PART	STANDARD MATERIALS	
	Body ⁽¹⁾	CF8M (SS 316)
Knife	SS 316	SS 317L
Seat ring ⁽²⁾	SS 316	SS 317L
O-ring ⁽²⁾	PTFE (standard), viton, neoprene, polyurethane, EPDM	
Yoke	CF8	
Stem ⁽¹⁾	SS 316 or SS 304	
Packing flange	CF8 (SS 304)	
Stem nut	Ni-resist or Bronze	
Bolt	SS 304	
Nut	SS 304 self-locking	
Packing	Graphite & PTFE-impregnated synthetic yarn (ph: 0-14)	
Thrust bearing	Steel, 14" - 24"	
Handwheel	Malleable iron	
Handwheel nut	Malleable iron, zinc plated	

(1) Other materials available (see page 17).

(2) Also available with integral metal seats.

DESIGN FEATURES:

- Designed to handle heavy slurries, pulp stock and corrosive fluids in process industries.
- Cast in austenitic stainless steel (30", 36" may be fabricated).
- Has through-bolted, rigid flanges matching B16.5 Class 150 regular, short-body type.
- Non-clogging full port design (metal seated valve).
- 150 psig (10.3 bar) max. working pressure. 150°F (65°C) max. working temperature. Applications outside of these conditions require special design considerations.
- The high quality metal seated knife valve with ground and lapped seating face have maximum leakage rates 4-10 times less than the permissible rates shown in TAPPI TIS 405-8 and MSS SP-81.
- Available with lever, chain, gear, electric, air or hydraulic actuation (see page 14).

DIMENSIONS AND WEIGHTS

SIZE in mm	A	C	BD	Bolt Hole in/mm	No. of Holes	D	D1	E	Knife	O Metal Seat	O Res. Seat	V-Port Area in ² /cm ²	lb kg
2 50	5.50 140	3.62 92	4.75 121	0.75 19.1	4	14.31 363	16.50 419	10.00 254	0.35 8.9	1.94 49	1.84 47	2.14 14	29 13
3 80	6.00 152	5.00 127	6.00 152	0.75 19.1	4	15.06 383	18.19 462	10.00 254	0.35 8.9	2.94 75	2.47 63	4.91 32	35 16
4 100	6.25 159	6.19 157	7.50 191	0.75 19.1	8	16.19 411	20.38 518	10.00 254	0.35 8.9	3.94 100	1.00 25	8.82 57	54 24
6 150	6.75 171	8.50 216	9.50 241	0.88 22.2	8	22.81 579	28.81 732	14.00 356	0.35 8.9	5.88 149	5.59 142	19.63 127	82 37
8 200	7.00 178	10.62 270	11.75 298	0.88 22	8	24.25 616	32.25 819	14.00 356	0.48 12.1	7.88 200	7.59 193	35.27 228	112 51
10 250	7.37 187	12.75 324	14.25 362	1.00 25.4	12	31.13 791	41.19 1046	18.00 457	0.48 12.1	9.88 251	9.59 244	55.46 358	172 78
12 300	8.00 203	15.00 381	17.00 432	1.00 25.4	12	32.63 829	44.75 1137	18.00 457	0.60 15.2	11.75 298	11.34 288	78.52 506	224 102
14 350	8.50 216	16.25 413	18.75 476	1.12 28.5	12	39.94 1014	53.75 1365	20.00 508	0.60 15.2	13.25 337	12.84 326	99.85 644	325 147
16 400	9.00 229	18.50 470	21.25 540	1.12 28.5	16	42.06 1068	57.75 1467	20.00 508	0.69 17.5	15.25 387	14.84 377	132.27 853	417 189
18 450	10.50 264	21.00 533	22.75 578	1.25 31.8	16	50.00 1270	67.63 1718	24.00 610	0.83 21.1	17.25 438	16.81 427	169.23 1092	552 250
20 500	10.50 267	23.00 584	25.00 635	1.25 31.8	20	52.68 1338	72.63 1845	24.00 610	0.94 23.9	19.25 489	18.81 478	210.75 1360	740 336
24 600	11.00 279	27.25 692	29.50 749	1.38 35.0	20	60.18 1529	84.00 2134	30.00 762	1.07 27.1	22.88 581	22.78 579	297.60 1920	960 435

**For Cv and
seat tightness
see chart on pg. 3
for metal seat and
pg. 4 for resilient seat**

**THE DETAIL BELOW
SHOWS THE INTEGRAL
METAL SEAT OPTION**

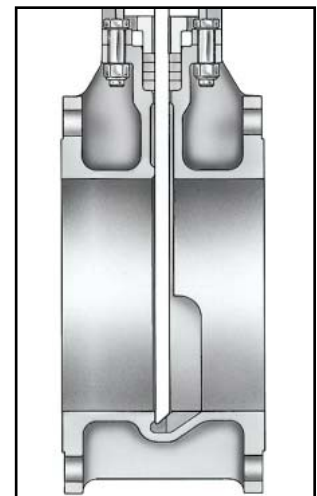
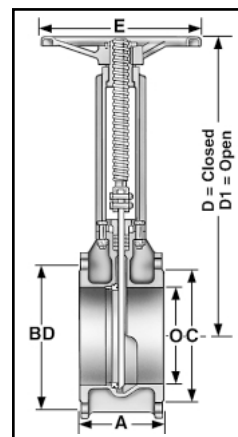

BOLTED BONNET KNIFE GATE VALVE DESIGN FEATURES

NO LEAKAGE TO THE EXTERIOR THROUGH PACKING CHAMBER (UNLIKE STANDARD KNIFE GATE VALVES)

- **Bonnetted design.**
Standard body-bonnet joint with an efficient non-asbestos reinforced fiber or PTFE gasket.
- **Long-life leakproof stem seal.**
Standard packing chamber with 125 RMS wall finish, burnished non-rotating stem and PTFE or graphite packing rings. **Many times the cycle life of a standard knife gate valve.**
- **Virtually no contamination of the environment.**
No dewatering of stock, unlike standard knife gate valves.
- **Easy repacking in-line.** (Valve should be de-pressurized when repacking in-line.)

TIGHTER SEATS WITH PATENTED TORQUE CLOSURE OF KNIFE

- **Beveled knife-stem connection** locks the knife blade tight against the seat. The seat is sealed by **positive torque closure** – not media pressure – unlike any other knife gate valve.
- **Raised-face seat.** A groove around the seat collects particles pushed aside by the knife and prevents clogging. When the valve opens, media pressure cleans the groove.
- **Lapped seat** ensures tight closure.
- **Crimped resilient seat** ensures longer service life (see pg.11).
- **Four seat designs:** Integral, resilient and renewable Stellite 6 (see pg. 10).

BYPASS TO PREVENT CLOGGING OF BONNET

- **Bypass** lets pulp circulate inside the bonnet when valve is opened, preventing clogging (*patent # 2093539 CDN and # 5295661 U.S.*).

EASY OPERATION

- **Lower running torque** due to reduced friction. Friction between stem and packing in bolted bonnet knife gate valve is far less than the friction between the blade and the packing in a standard knife gate valve.
- **Low-friction, acid-resistant Ni-Resist stem nut.**
- **Valves can operate with smaller actuators** than standard knife gate valves.

ALL CAST STAINLESS STEEL DESIGN

- **One-piece stainless steel**, fully-lugged, cast body is stronger than welded bodies and less subject to distortion due to thermal stress. Posts are stainless steel instead of chrome-plated carbon steel for longer life.
- **Designed for vertical or horizontal** line operations.
- **Standard wafer, TAPPI face-to-face** for easy replacement of leaky standard knife gate valves.
- **Maintenance and adjustment-free.** Long cycle life.
- **Suitable for most pulp and paper applications.**
Can be used throughout the mill as a general-purpose knife gate valve.

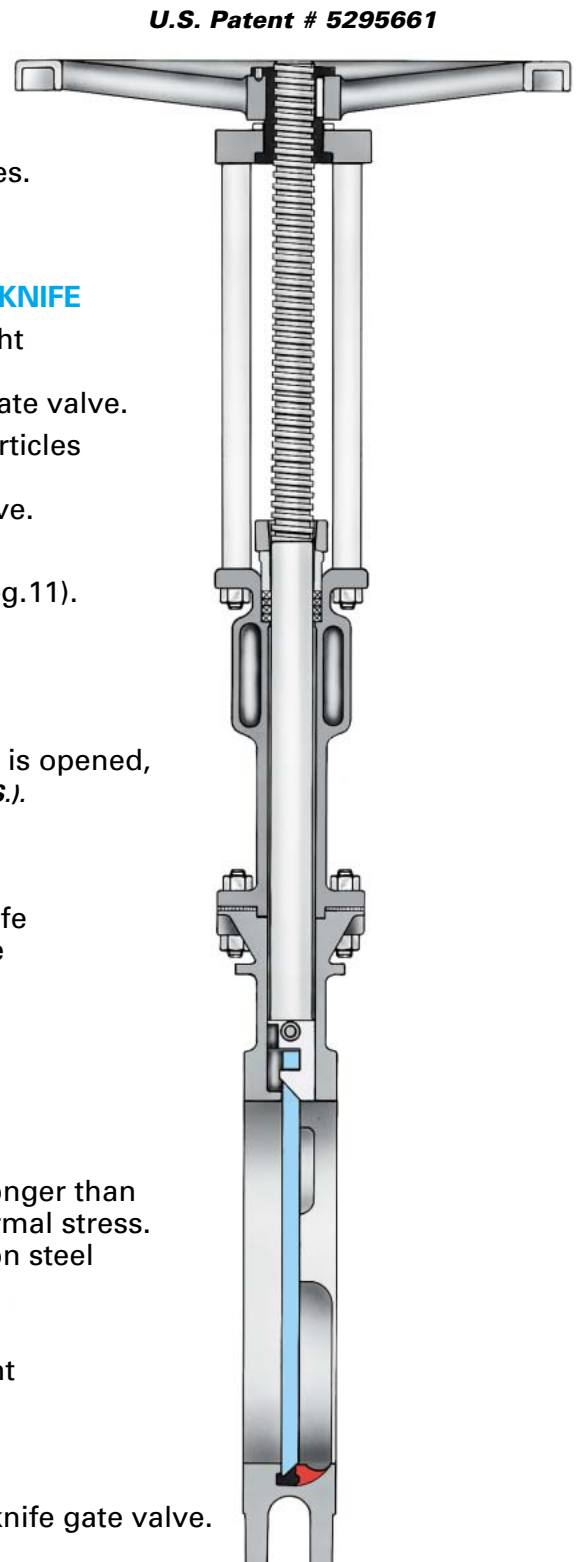

THE VELAN BOLTED BONNET KNIFE GATE VALVE

PROVIDES POSITIVE SEATING ON THE BOTTOM AND THE TOP OF THE BLADE

- **Patented knife – stem connection.**

Unlike any other design, the stem head slides inside a circular cavity on the stem guides in the body and bonnet, and is connected to the knife blade by a taper slot. A roller prevents the stem from rotating.

- **Handwheel torque or actuator force provides positive seat-knife closure.**

During closure, the stem slides down pushing the knife into contact with the

two bottom lugs. The taper stem head then transfers a vertical closing force to a lateral force which positively seats the knife against the seat face. Stem force, not line pressure, maintains seating contact in this unique design, ensuring tight seating in both directions (see alternative seat designs on page 10). During the opening and closing cycle, the guides ensure proper alignment of the knife.

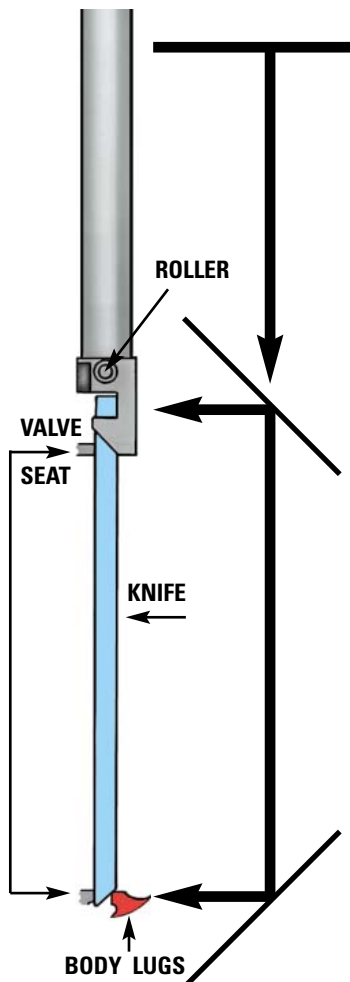

**THE BONNET & BODY
ARE SPECIALLY
DESIGNED TO PERMIT
PULP CIRCULATION**

**THIS PREVENTS
CLOGGING**

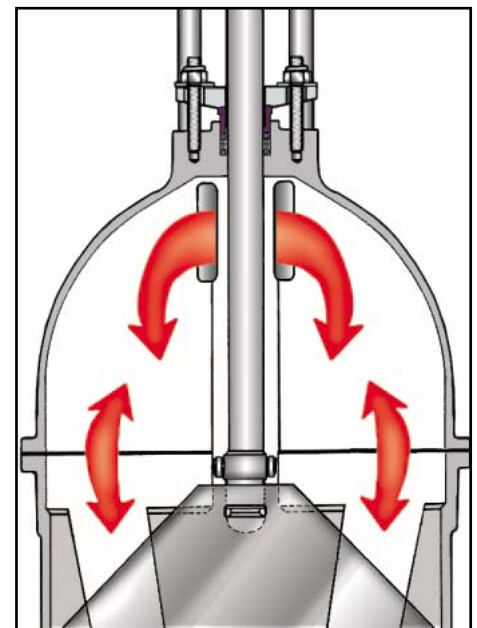



ALL STAINLESS STEEL BOLTED BONNET KNIFE GATE VALVES, FULL PORT, 4–24" (100–600 mm)

FOR BIDIRECTIONAL SHUTOFF UP TO 150 PSI (10.3 BAR),
FULLY LUGGED, TYPE 310B METAL SEAT



PART		STANDARD MATERIALS	
Body ⁽¹⁾		CF8M (SS316)	CG8M (SS317)
Bonnet		CF8M	CG8M
Post		SS316	
Knife		SS316	SS317
SEAT	Integral	CF8M (SS316)	CG8M (SS317)
	Hardfaced	Stellite 6	
Stem ⁽¹⁾		SS316/SS 304	SS317
Stem nut		Ni-Resist or Bronze	
Gland bushing		SS316 or SS304	
Packing flange		CF8M or CF8	
Bolt		SS304 or SS316	
Nut		SS304 (self-locking) or SS316	
Packing		Graphite & PTFE-impregnated synthetic yarn (ph: 0-14)	
Cam follower		SS316	SS317
Gasket		PTFE or reinforced fiber	
Handwheel		Malleable iron	

(1) Other materials available (see page 17).

DESIGN FEATURES:

- All stainless steel construction.
- Seat tightness achieved with torque as opposed to line pressure.
- Thoroughly tested in a variety of applications including: clean pulp up to a consistency of 5%, waste water and secondary effluent.
- Bypass unit cast into the bonnet prevents clogging.
- Conventional packing chamber eliminates leakage problems associated with standard knife valves.
- 150 psig (10.3 bar) max. working pressure.
150°F (65°C) max. working temperature.
Applications outside of these conditions require special design considerations.

DIMENSIONS AND WEIGHTS

SIZE in mm	A	C	BD	Tap Size in (UNC)	No. of Holes	D	D1	E	Knife	O Metal Seat	WEIGHT lb kg
4 100	2.00 51	5.91 150	7.50 191	0.625-11	8	17.00 432	21.00 533	8.00 203	0.35 9	3.95 100	33.50 12.5
6 150	2.25 57	8.50 216	9.50 241	0.75-10	8	22.25 565	28.34 720	10 254	0.40 10	5.75 146	65 29.5
8 200	2.75 70	10.62 270	11.75 298	0.75-10	8	27.37 695	35.75 908	10 254	0.57 14	7.88 200	95 43.1
10 250	2.75 70	12.75 324	14.25 362	0.88-9	12	33.50 851	43.68 1109	14 356	0.57 14	9.88 251	155 70.3
12 300	3.00 76	15.00 381	17.00 432	0.88-9	12	38.56 979	50.62 1286	14 356	0.65 16.5	11.75 298	190 86.2
14 350	3.00 76	16.25 413	18.75 476	1.00-8	12	42.43 1078	56.00 1422	14 356	0.65 16.5	13.25 337	230 104.3
16 400	3.50 89	18.50 470	21.25 540	1.00-8	16	47.63 1210	63.00 1600	18 457	0.69 17	15.25 387	315 142.9
18 450	3.50 89	21.00 533	22.75 578	1.12-7	16	53.25 1353	70.68 1795	18 457	0.83 21	17.25 438	475 215.5
20 500	4.50 114	23.00 584	25.00 635	1.12-7	20	58.87 1495	78.37 1991	18 457	0.94 24	19.25 489	650 294.8
24 600	4.50 114	27.25 692	29.50 749	1.25-7	20	68.43 1738	91.53 2325	20 508	0.94 24	22.88 518	890 403.7

For Cv & seat tightness
see chart on page 3

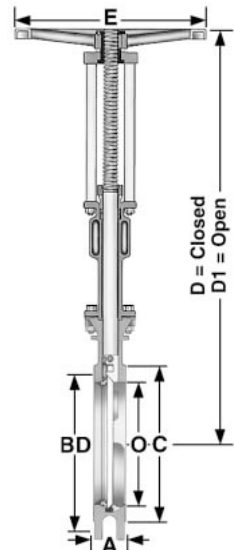



**ALL STAINLESS STEEL BOLTED BONNET
KNIFE GATE VALVES, FULL PORT, 4–24" (100–600 mm)**
FOR BIDIRECTIONAL SHUTOFF UP TO 150 PSI (10.3 BAR),
FULLY LUGGED, TYPE 320B RESILIENT SEAT



PART	STANDARD MATERIALS	
Body ⁽²⁾	CF8M (SS316)	CG8M (SS317)
Bonnet	CF8M	CG8M (SS317)
Post	SS316	
Knife	SS316	SS317
Seat ⁽¹⁾	PTFE	
Stem ⁽²⁾	SS316/SS 304	SS317
Stem nut	Ni-Resist or Bronze	
Gland bushing	SS316 or SS304	
Packing flange	CF8M or CF8	
Bolt	SS304 or SS316	
Nut	SS304 (self-locking) or SS316	
Packing	Graphite & PTFE-impregnated synthetic yarn (ph: 0-14)	
Cam follower	SS316	SS317
Gasket	PTFE or reinforced fiber	
Handwheel	Malleable iron	

(1) PTFE recommended as standard. Other materials available.
(2) Other materials available (see page 17).

DESIGN FEATURES:

- All stainless steel construction.
- Seat tightness achieved with torque as opposed to line pressure.
- Bidirectional shutoff from 0 to 150 psi (10.3 bar).
- Thoroughly tested in a variety of applications including white water and weak black liquor.
- Bypass unit cast into the bonnet prevents clogging.
- Conventional packing chamber eliminates leakage problems associated with standard knife valves.
- 150 psig (10.3 bar) max. working pressure.
150°F (65°C) max. working temperature.
Applications outside of these conditions require special design considerations.

DIMENSIONS AND WEIGHTS

SIZE in mm	A	C	BD	Tap Size in (UNC)	No. of Holes	D	D1	E	Knife	O Resilient Seat	WEIGHT lb kg
4 100	2.00 51	5.91 150	7.50 191	0.625-11	8	17.00 432	21.00 533	8.00 203	0.35 9	3.47 100	33.50 12.5
6 150	2.25 57	8.50 216	9.50 241	0.75-10	8	22.25 565	28.34 720	10 254	0.40 10	5.59 142	65 29.5
8 200	2.75 70	10.62 270	11.75 298	0.75-10	8	27.37 695	35.75 908	10 254	0.57 14	7.59 193	95 43.1
10 250	2.75 70	12.75 324	14.25 362	0.88-9	12	33.50 851	43.68 1109	14 356	0.57 14	9.59 244	155 70.3
12 300	3.00 76	15.00 381	17.00 432	0.88-9	12	38.56 979	50.62 1286	14 356	0.65 16.5	11.34 288	190 86.2
14 350	3.00 76	16.25 413	18.75 476	1.00-8	12	42.43 1078	56.00 1422	14 356	0.65 16.5	12.84 326	230 104.3
16 400	3.50 89	18.50 470	21.25 540	1.00-8	16	47.63 1210	63.00 1600	18 457	0.69 17	14.84 377	315 142.9
18 450	3.50 89	21.00 533	22.75 578	1.12-7	16	53.25 1353	70.68 1795	18 457	0.83 21	16.81 427	475 215.5
20 500	4.50 114	23.00 584	25.00 635	1.12-7	20	58.87 1495	78.37 1991	18 457	0.94 24	18.81 478	650 294.8
24 600	4.50 114	27.25 692	29.50 749	1.25-7	20	68.43 1738	91.53 2325	20 508	0.94 24	22.78 579	890 403.7

For Cv & seat tightness
see chart on page 3

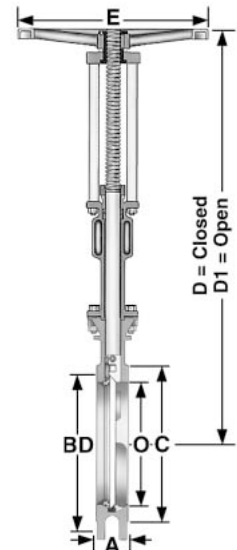

OPTIONS



"V" orifices

- **"V" ORIFICE**

Flow data on page 12.

- **OPERATION**

Handwheel, quick lever, chain wheel, bevel gear, on-off cylinder actuators, positioning cylinder actuators, electric actuators.

- **DEFLECTION CONES**

In stainless steel or other materials are available to divert the flow of abrasive slurries and protect valve seat from abrasion.

Typical applications include dry solids, storage bins, bottom valves, mining slurries, fly ash, filters, cyclons, etc. The cone is installed between valve and pipe flange.



Deflection Cones

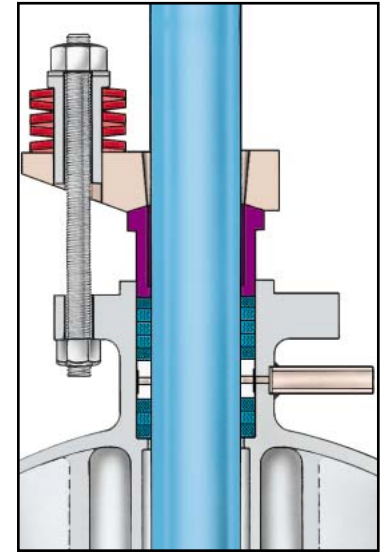

Double Packing Lantern Ring
Live-loading and leak-off

- **BONNET PURGE CONNECTORS**

For very fine slurry lines, purge connections are recommended. Purging is used to prevent packing of material in bonnet areas.

- **BODY PURGE CONNECTIONS**

For higher density pulp applications consult factory.

Stem protectors available upon request.

ALTERNATIVE SEAT DESIGNS

①

- ① **Integral Seat**

- Pulp and paper
- Chemical industry
- Food processing
- Agriculture
- Petrochemical industries
- Sugar industry
- Textile industry fibers and waste water

②

- ② **Polyurethane Seat & Deflector**
(available on Standard Knife Gate Valves only)

- Waste water treatment
- Water plants
- Abrasive mining slurries
- Pipelines

③

- ③ **Resilient Seat**

- Pulp & paper
- Chemical industry
- Food processing
- Petrochemical industries
- Textile industry

④

- ④ **Renewable Stellite 6 Seat and Deflector**

- Tough applications in pulp and paper
- Coal liquefaction
- Abrasive mining slurries
- Granulated ore in water
- Fly ash lines
- Coal pipelines

⑤

- ⑤ **Integral Stellite 6 Hardfaced Seat with Special Body Designed to Match Basalt Pipe Flanges**
(available on Bolted Bonnet Knife Gate Valve only)

- Tough Lignite bottom ash slurry service

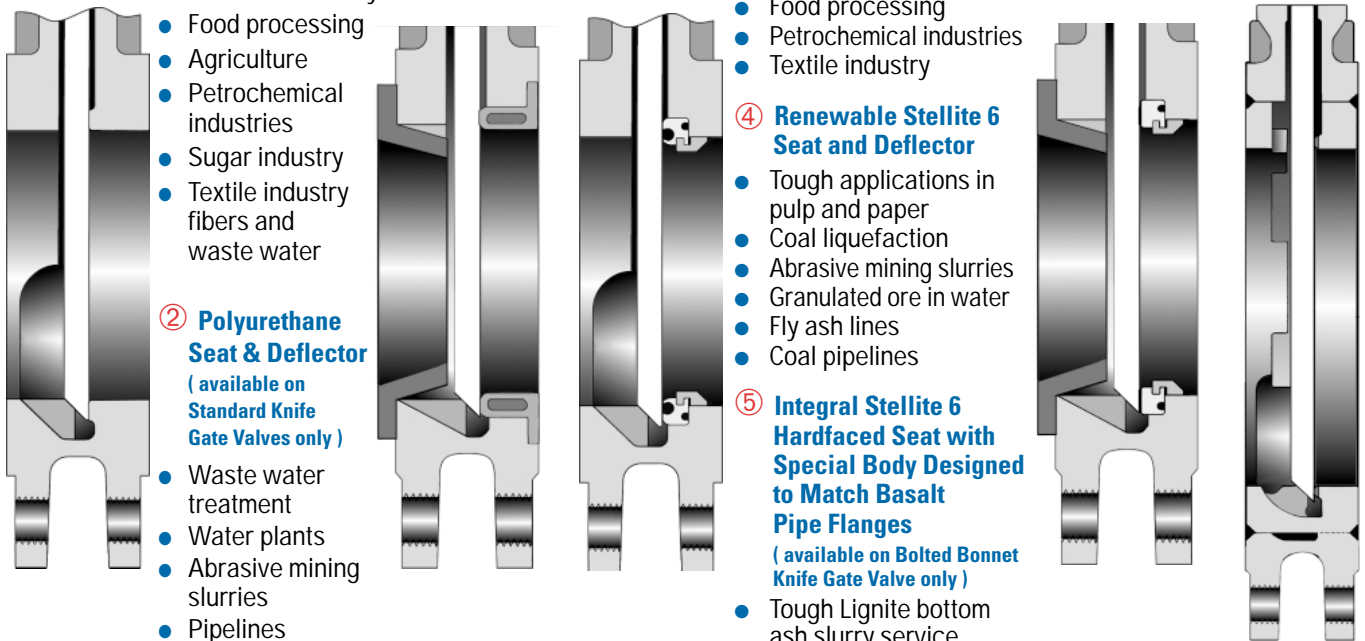

2-16" STANDARD KNIFE GATE VALVE

INTEGRAL CRIMPED RESILIENT SEAT

A NEW INTEGRAL CRIMPED RESILIENT SEAT IS NOW STANDARD ON 2-12" STANDARD KNIFE GATE VALVE

Old "snap-in" style seats could be too easily extracted accidentally by friction caused by heavy or infrequent cycling. Velan's new "crimped seat" makes accidental extraction virtually impossible. The seat will wear normally but the crimped design keeps it tight inside the seat retainer ring for a longer cycle life.

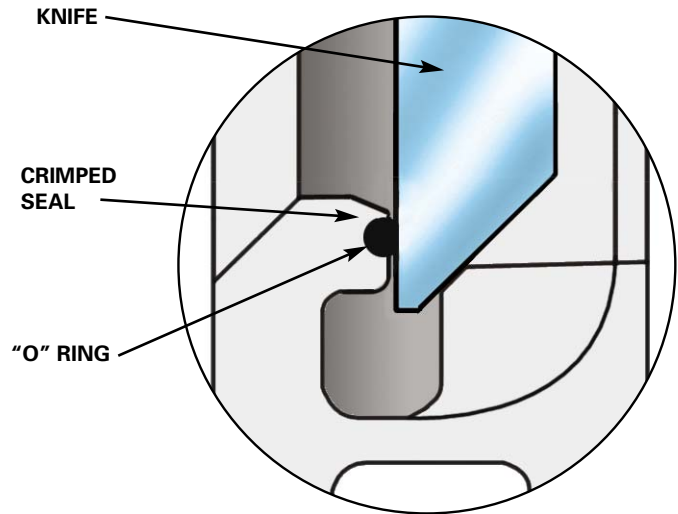

18-36" STANDARD KNIFE GATE VALVE & BOLTED BONNET KNIFE GATE VALVE ALL SIZES

STAINLESS STEEL SEAT RING WITH REPLACEABLE CRIMPED RESILIENT SEAT OPTION PREVENTS ACCIDENTAL EXTRACTION

CRIMPING THE SEAT STEP BY STEP

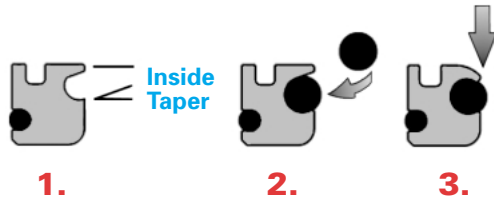

1. The stainless steel seat ring is manufactured with a slight inside taper.
2. The O-ring is inserted.
3. Seat ring is progressively crimped on a lathe to imprison the O-ring in it.

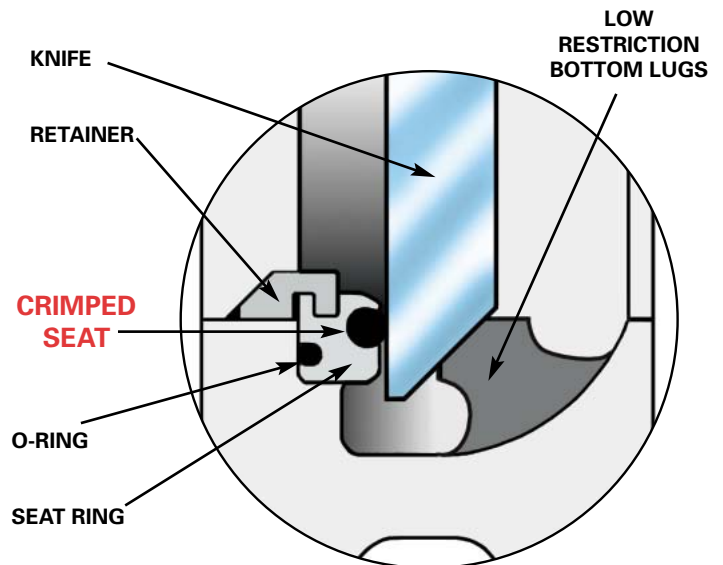
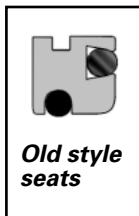

LOW RESTRICTION LUGS BOTTOM

An important breakthrough in bottom lug design for Pulp and Paper applications, the Velan Bolted Bonnet Knife Gate valve features a bottom lug that permits longer fibers to circulate on each side preventing clogging during closing. This improvement is currently available on most sizes.

RESILIENT SEAT MATERIAL		
TYPE	MAX. TEMP.	USE
Black neoprene	180°F	Alkaline
Off-white neoprene	180°F	Prevent color contamination
Viton, standard on bolted bonnet knife gate valve	400°F	Chemicals
EPDM	250°F	Food grade
PTFE	400°F	Food
Polyurethane	210°F	Waste water

SUPERIOR KNIFE

OUR KNIVES ARE THICKER, STRONGER AND HAVE A BETTER SEATING FINISH

- **Thicker knife.** Our valves have thicker, stronger knives, to prevent deflection under heavy pressure and to ensure a tight seal.

The minimum knife thickness for Velan knife gate valves are based on the ASME VIII formula for plate thickness.

- **Precision-machined, bottom and top edges** provide shearing action for pulp stock and slurry.
- **Lapped seating face** for maximum tightness.

For specific Knife Gate Valve thicknesses see tables on pages 3, 4, 5, 8 & 9



EASY MAINTENANCE

Easy seat maintenance due to replaceable seat retainer ring on standard knife gate valves from 8–36" and bolted bonnet knife gate valves from 6–24".

Simply grinding off the seat ring retainers on the valve body permits extraction of the seat through the packing chamber. Since Velan features a crimped

seat, the O-ring cannot be replaced. A new seat ring, including a crimped in O-ring can easily be put back into place and secured there by tack welding the retainers.

This operation can be done many times insuring that the Velan knife gate valve gives years of reliable service.

For complete maintenance procedure including important pipe flange bolt torquing specifications, please refer to the Knife Gate Valve Maintenance Manual VEL-KGVM-99



ENGINEERING DATA

FLOW CHART CHARACTERISTICS

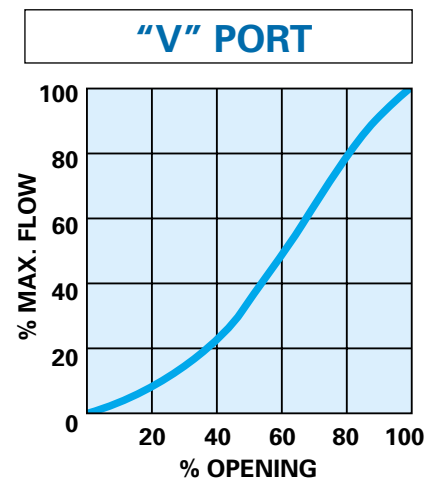
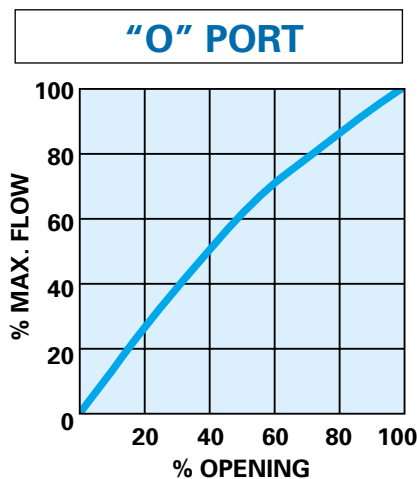

IN-SERVICE PHOTOS



Centrifugal cleaner isolation. Pressure around 25-35 psi (1.7-2.4 bar) 2.5% pulp.

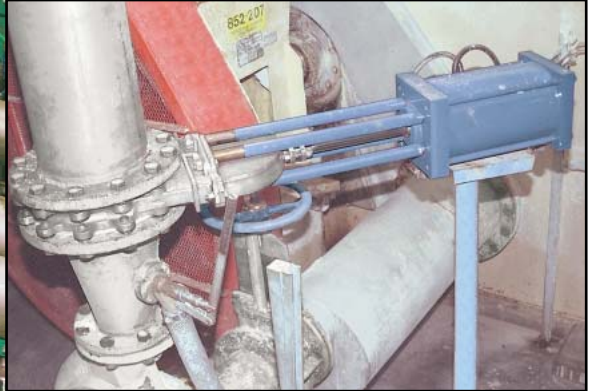

Pump discharge shutoff
5% pulp at 70 psi (4.8 bar) cycling
over 75 times a day.

Due to unique torque closure of its' seat, the Velan Bolted Bonnet Knife Gate Valve is an ideal solution for low pressure, high cycling, environmentally sensitive services and bidirectional applications.

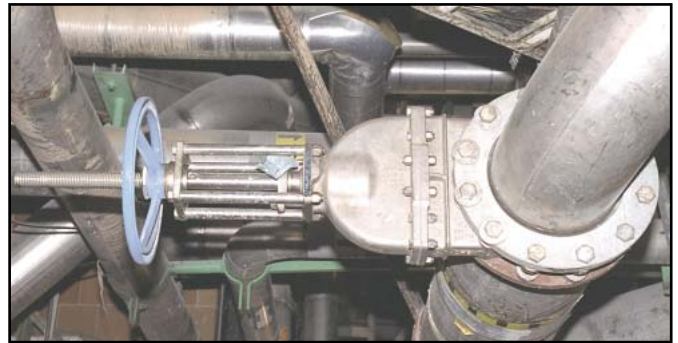

Post refiner line isolation.



Multiple pump discharge isolation with pressure 70-90 psi (4.8-6.2 bar) white water.



Filter isolation installation.

ACTUATORS



GEAR ACTUATORS

Our standard handwheels suffice to reduce rimpull to acceptable levels. An optional oversized handwheel or VT-20 gear actuator can be supplied for 16" to 24" valves.

ELECTRIC ACTUATORS

Motorized controls may be applied to valves of any size, for operation in practically any position or location. All units, whether installed directly on a valve or on a floor stand, can be manually operated in case of power failure. The units are available for either alternating or direct current and are sized for specified conditions of operation. Motor units are available with limit switches and push button controls which can be selected to meet customers' requirements.

CYLINDER ACTUATORS

Various types of cylinders are available for operating Velan knife gate valves. The most commonly-used cylinders are operated by air, but oil and water types are available if required.

In most designs, the valve stem serves as a piston rod, with the knife fastened directly to the actuator. Actuators with

double-ended piston rod option can be supplied to install position indicators or limit switches and for connecting an emergency device for manual actuation of the valve.

Handwheels and gear boxes can be mounted on top of the cylinders for emergency operation due to loss of operating medium in the cylinder.

If specified by the customer, Velan valves can be furnished with mounting pads for most steel cylinders or valve positioners for throttling control.

BORE DIAMETER (in) FOR DOUBLE-ACTING PNEUMATIC ACTUATOR																
Valve SIZE IN	MAXIMUM DIFFERENTIAL PRESSURE (PSI)															
	40		50		60		70		80		100		125		150	
	C	B	C	B	C	B	C	B	C	B	C	B	C	B	C	B
2	3/4	-	3/4	-	3/4	-	3/4	-	3/4	-	3/4	-	3/4	-	3/4	-
3	3/4	-	3/4	-	3/4	-	3/4	-	3/4	-	3/4	-	3/4	-	3/4	-
4	4	3/4	4	3/4	4	3/4	4	3/4	4	3/4	4	3/4	4	3/4	4	3/4
6	5	3/4	5	3/4	5	3/4	5	3/4	5	3/4	5	4	5	4	5	5
8	5	3/4	5	4	6	4	6	4	6	5	6	5	6	6	7	6
10	6	4	6	5	6	5	6	5	6	6	7	6	7	7	8	7
12	7	5	7	5	7	6	7	6	7	6	8	7	10	8	10	8
14	7	5	7	6	7	6	8	7	8	7	10	8	10	10	10	10
16	8	6	8	7	8	7	10	8	10	8	10	10	12	10	12	12
18	10	7	10	7	10	8	10	8	10	10	12	10	12	12	14	12
20	10	7	10	8	10	10	12	10	12	10	12	12	14	12	14	14
24	12	8	12	10	12	10	14	12	14	12	14	14	16	14	18	16
30	12	-	14	-	14	-	16	-	16	-	18	-	20	-	20	-
36	14	-	16	-	18	-	18	-	20	-	20	-	22	-	24	-

NOTE: Above sizes are based on 80 psi air pressure.
C = conventional B = bolted bonnet

ELECTRIC ACTUATOR SIZES ¹										
CONVENTIONAL KNIFE GATE VALVE										
Valve SIZE IN	MAXIMUM DIFFERENTIAL PRESSURE (PSI)									
	Limotorque L120					Rotork				
	50	75	100	125	150	50	75	100	125	150
2	10/3	10/3	10/3	10/3	10/3	7 AZ	7 AZ	7 AZ	7 AZ	7 AZ
3	10/3	10/3	10/3	10/3	10/3	7 AZ	7 AZ	7 AZ	7 AZ	7 AZ
4	10/3	10/3	10/3	10/3	10/3	7 AZ	7 AZ	7 AZ	7 AZ	7 AZ
6	10/3	10/3	10/3	10/3	10/3	7 AZ	7 AZ	7 AZ	7 AZ	7 AZ
8	10/3	10/3	10/3	10/3	10/3	7 AZ	7 AZ	7 AZ	7 AZ	11 AZ
10	10/3	10/3	10/3	10/3	10/3	7 AZ	11 AZ	11 AZ	11 AZ	11 AZ
12	10/3	10/3	10/3	10/3	10/5	11 AZ	11 AZ	11 AZ	11 AZ	14 A
14	10/3	10/5	10/5	10/5	10/5	14 A	14 A	14 A	14 A	14 A
16	10/5	10/5	10/5	10/5	10/7.5	14 A	14 A	14 A	14 A	14 A
18	10/7.5	10/7.5	10/7.5	20/7.5	10/7.5	14 A	14 A	14 A	16 A	16 A
20	20/7.5	20/7.5	20/7.5	20/10	20/10	14 A	14 A	16 A	16 A	16 A
24	20/7.5	20/10	20/10	20/15	20/15	16 A	16 A	16 A	16 A	16 A
30	20/10	40/10	40/15	40/15	40/15	16 AZ	30 A	30 A	30 A	30 A
36	40/15	40/15	40/15	20/10 & B320-20	30 A	30 A	40 A	40 A	40 A	40 A
BOLTED BONNET KNIFE GATE VALVE										
4	10/3	10/3	10/3	10/3	10/3	7 A	7 A	7 A	7 A	7 A
6	10/3	10/3	10/3	10/3	10/3	7 A	7 A	7 A	7 A	7 A
8	10/3	10/3	10/3	10/3	10/3	7 A	7 A	7 A	7 A	7 A
10	10/3	10/3	10/3	10/3	10/3	7 AZ	7 AZ	7 AZ	11 AZ	11 AZ
12	10/3	10/3	10/3	10/3	10/3	7 AZ	11 AZ	11 AZ	11 AZ	11 AZ
14	10/3	10/3	10/3	10/3	10/3	14 A	14 A	14 A	14 A	14 A
16	10/3	10/3	10/3	10/3	10/5	14 A	14 A	14 A	14 A	14 A
18	10/3	10/3	10/3	10/5	10/5	14 A	14 A	14 A	14 A	14 A
20	10/3	10/3	10/5	10/5	20/7.5	14 A	14 A	14 A	16 A	16 A
24	10/3	10/5	10/7.5	20/7.5	20/15	14 A	14 A	16 A	16 A	16 A

(1) AUMA also available.

NOTE: Based on 460V/3Ph/60Hz + - 10% voltage variation.



ALL STAINLESS, FABRICATED OR CAST TYPE 33 KNIFE GATE VALVE FOR THROTTLING 3–24" (80–600 mm)

"O" OR DIAMOND PORT, FULL PORT, 150 PSIG (10.3 BAR)

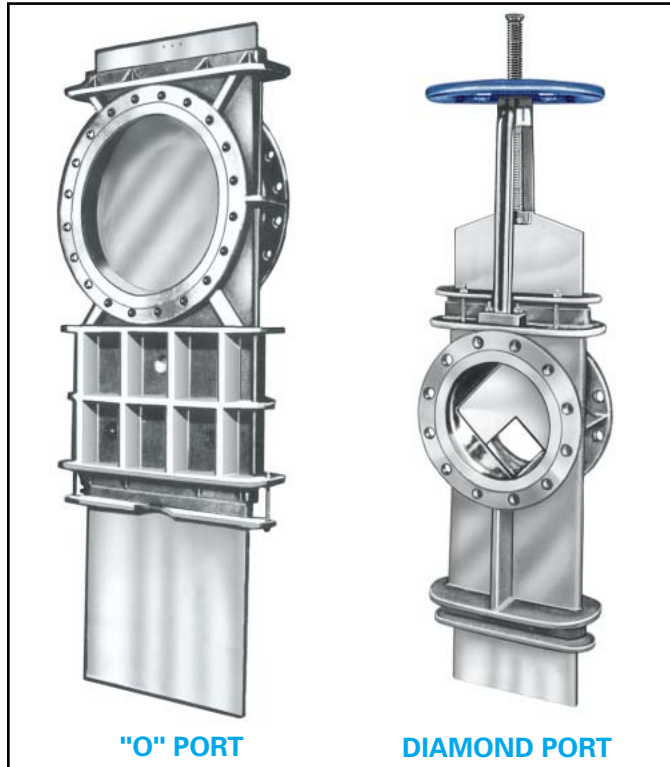

"O" PORT

DIAMOND PORT

Gear, pneumatic or electric actuators available

MATERIALS

ITEM	MODEL	
	A	B
Knife	T316	T317ELC
Body	T316	T317ELC
Bolt	Stainless steel	
Packing	PTFE-impregnated asbestos or PTFE-impregnated synthetic yarn	
Packing flange	T304	T304
Stem	T304 Stainless steel	
Yoke	T304 Stainless Steel	
Stem nut	Ni-resist or Bronze	
Handwheel	Ductile iron	

DESIGN FEATURES:

- Linear flow from low to full opening.
- Non-plugging bonnet and throttle orifice.
- Machined seat allows tight shutoff.
- Beveled gate provides positive shearing action.
- Port closure directly proportional to stem travel for throttling.
- Throttles dense solutions of paper mill stock for headbox flow control, etc.
- All interior surfaces exposed to piped liquid are stainless steel. Full stainless gasket surfaces.
- Deep packing glands eliminate leakage.
- Simple single yoke construction eliminates outside gearing and bearings.

DIMENSIONS AND WEIGHTS

SIZE in mm	A Face to Face	C Flange Diameter	BD Bolt Circle	D Center to Top Closed	Center to Bottom Closed	E Handwheel Diameter	DI Center to Top Open	Center to Bottom Open	Cv Round Port	Cv Diamond Port	WEIGHT lb kg
3 80	2 51	7.5 191	6 152	17 432	13.25 337	12 305	19.25 489	10.25 260	362	210	80 36
4 100	2 51	9 229	7.5 191	20.25 514	16.25 413	12 305	23.75 603	12 305	646	386	108 49
6 150	2.25 57	11 279	9.5 241	22.75 578	22.25 565	12 305	28.75 730	15.5 394	1,450	900	160 73
8 200	2.75 70	13.5 343	11.75 298	27.75 705	26.25 667	12 305	35.25 895	18 457	2,570	1,600	220 98
10 250	2.75 70	16 406	14.25 362	31.75 806	31.5 800	15 381	41.25 1048	21 533	3,423	2,300	270 122
12 300	3 76	19 483	17 432	36.25 921	37 940	15 381	48 1219	24.25 616	5,674	3,700	320 145
14 350	3 76	21 533	18.75 476	39 991	40.25 1022	20 508	52.25 1327	26.25 667	7,069	4,600	400 181
16 400	3.5 89	23.5 597	21.25 540	43.75 1111	45.25 1149	24 610	59 1499	29.25 743	9,365	6,150	510 231
18 450	3.5 89	25 635	22.75 578	48 1219	50 1270	24 610	65.25 1657	32 813	11,892	8,200	630 286
20 500	4.5 114	27.5 699	25 635	52.25 1327	55 1397	30 762	72.25 1835	35 889	14,922	10,050	780 354
24 600	4.5 114	32 813	29.5 749	58 1473	65 1651	30 762	81 2057	41 1041	20,550	15,000	1190 540



TILTING DISC CHECK VALVES THROUGH-BOLTED FLANGES, 2½ -24" (65-600 mm)

ASME B16.5 CLASS 150, TYPE 34

STANDARD MATERIALS

PART	MATERIAL	
Body	CF8M	CG3M
Seat ring	CF8M	CG3M
Disc	CF8M	CG3M
Gasket	PTFE or reinforced fiber	
Bolt	SS 304	
Nut	SS 304 (self-locking)	

DESIGN FEATURES:

- Manufactured in corrosion-resistant stainless steel.
- Precision machined tilting disc and seat for tight shutoff in reverse flow direction.
- Designed with an off-center pivot to prevent the disc from slamming against the seat and to aid operation at low pressure differentials.
- Can be installed in both the horizontal or vertical positions, provided fluid flow is upward.
- Rugged construction, simple and lightweight.
- 150 psig (10.3 bar) max. working pressure. 150°F (65°C) max. working temperature. Applications outside of these conditions require special design considerations.
- Flanges meet ASME B16.5, Class 150.
- Serrated gasket faces.

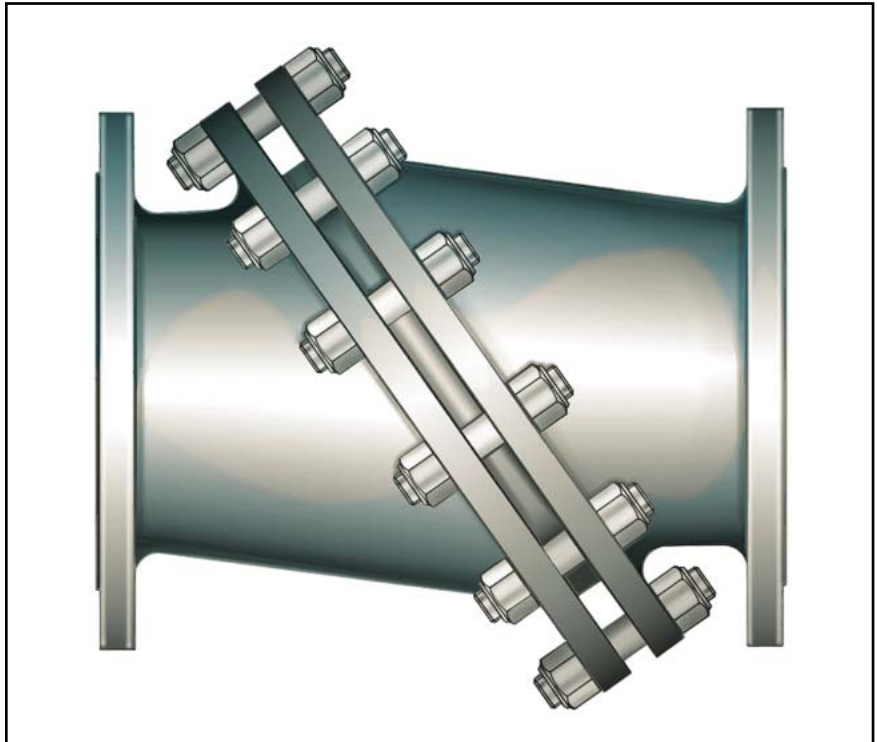

DIMENSIONS AND WEIGHTS

SIZE in mm	A Face to Face	C Flange Diameter	BD Bolt Circle	No. of Holes	Hole Size	Maximum Width	Weight lb kg
2.5 65	8.50 216	7.00 178	5.50 140	4	0.75 19	8.75 222	30 14
3 80	9.50 241	7.50 191	6.00 152	4	0.75 19	9.75 248	45 20
4 100	11.50 292	9.00 229	7.50 191	8	0.75 19	11.50 292	65 29
6 150	14.00 356	11.00 279	9.50 241	8	0.88 22	13.50 343	95 43
8 200	18.00 457	13.50 343	11.75 298	8	0.88 22	16.00 406	145 66
10 250	21.75 552	16.00 406	14.25 362	12	1.00 25	19.00 483	250 113
12 300	25.25 641	19.00 483	17.00 432	12	1.00 25	21.75 552	310 141
14 350	28.00 711	21.00 533	18.75 476	12	1.12 29	25.00 635	397 180
16 400	30.00 762	23.50 597	21.25 540	16	1.12 29	28.00 711	505 229
18 450	31.00 787	25.00 635	22.75 578	16	1.12 32	29.50 749	550 249
20 500	32.50 826	27.50 699	25.00 635	20	1.12 32	32.75 832	790 358
24 600	34.00 864	32.00 813	29.50 749	20	1.38 35	38.75 984	1100 499

NOTE:
Flanges drilled
to match
ASME B16.5 Class 150.

HOW TO ORDER

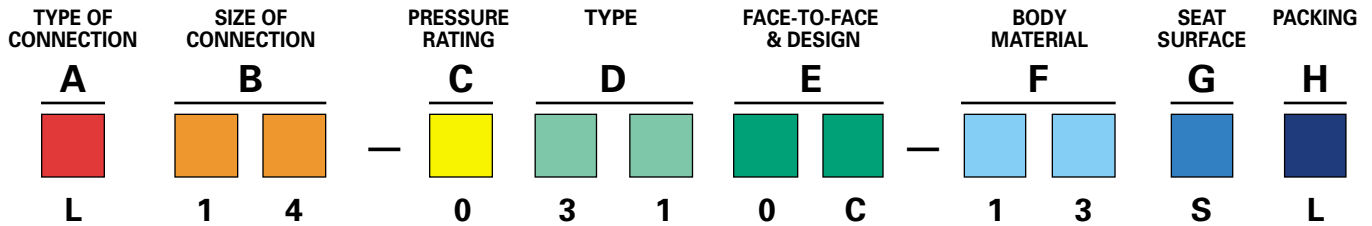

Example: 6", lug, 150 class, metal-seated, cast, stainless steel knife gate valve.

A TYPE OF CONNECTION	
B - Butt weld	N - Wafer
C - Combination (socket weld/threaded)	P - Flanged B16.47 series B (API 605)
D - DIN flanged	R - Flanged ring joint
E - Welded stubs butt weld	S - Threaded
F - Flanged B16.5 (B16.47 series A)	T - Studded drilled & tapped
G - Small tongue and groove	U - Undrilled flanges
H - Hub ends	X - Butt weld (intermediate class)
L - Lug	W - Socket weld
	Z - Welded stubs socket weld

B SIZE OF CONNECTION	
Customers have the choice of specifying valve size as part of the valve figure number (B) using the numbers below, or indicating valve size separately.	
EXAMPLES:	
L14-0310C-13SL (valve size is part of figure number)	
6"L-0310C-13SL (valve size is shown separately)	
08 - 2" (50 mm)	15 - 8" (200 mm)
09 - 2½" (65 mm)	16 - 10" (250 mm)
10 - 3" (80 mm)	18 - 12" (300 mm)
12 - 4" (100 mm)	19 - 14" (350 mm)
14 - 6" (150 mm)	20 - 16" (400 mm)
21 - 18" (450 mm)	22 - 20" (500 mm)
23 - 22" (550 mm)	24 - 24" (600 mm)
26 - 26" (650 mm)	28 - 28" (700 mm)
30 - 30" (750 mm)	32 - 32" (800 mm)
34 - 34" (850 mm)	36 - 36" (900 mm)

C PRESSURE RATING	
0 - 150	

D TYPE	
31 - Metal seat	34 - Tilting disc check valve
32 - Soft seat	37 - V-port
33 - Throttling stock valve	38 - Knife gate with seat insert

E FACE TO FACE		DESIGN	
0 - Tappi standard (wafer)	1 - ASME/ANSI standard (flanged)	B - Cast (bolted bonnet)	C - Cast (bonnetless)
2 - Regular (flanged)		F - Fabricated	

F BODY MATERIAL		
02 - A105, WCB	14 - F316L, CF3M	34 - F91, C12A
11 - F304, CF8	23 - Alloy 20	35 - F44, 254 5MO
12 - F304L, CF3	28 - F317, CG8M	
13 - F316, CF8M	29 - F317L, CG3M	

G SEAT SURFACE		
B - Viton	F - PTFE	S - Integral
C - Black Neoprene	M - Stellite	W - White Neoprene
E - EPDM	P - Polyurethane	

H PACKING		
C - Graphite/Inconel	F - PTFE 0-14 ph	L - Spun synthetic 4-10 ph
Filament 0-14 ph	G - Graphite 0-14 ph	T - PTFE/Graphite 0-14 ph

The figure numbers shown on this key are designed to cover essential features of Velan valves. Please use figure numbers to ensure prompt and accurate processing of your order. A detailed description must accompany any special orders.

MATERIAL SPECIFICATIONS

ASTM DESIGNATION	CAST				BAR STOCK		PLATE	
	316	316L	304	317L	316	304	316	
	A351 CF8M	A351 CF3M	A351 CF8	A351 CG3M				
COMPOSITION %	Carbon	0.08	0.03	0.08	0.03	0.08	0.08	0.08
	Manganese	1.50	1.50	1.50	1.50	2.00	2.00	2.00
	Phosphorus	0.04	0.04	0.04	0.04	0.045	0.04	0.045
	Sulphur	0.04	0.04	0.04	0.04	0.030	0.03	0.03
	Silicon	1.50	1.50	2.00	1.50	1.00	1.00	0.75
	Nickel	9.00-12.00	9.00-13.00	8.00-11.00	11.5-13.5	10-14	8.00-10.50	10.00-14.00
	Chromium	18.00-21.00	17.00-21.00	18.0-21.00	20.5-23.5	1-18	18.00-20.00	16.00-18.00
	Molybdenum	2.00-3.00	2.00-3.00	—	3.00-4.00	2.00-3.00	—	2.00-3.00
Heat Treatment	Solution anneal							
Tensile ksi min.	70	70	70	75	75	75	75	
Yield ksi min.	30	30	30	35	30	30	30	
Elong. % min.	30	30	35	25	30	30	40	
R. area % min.	—	—	—	36	40	40	—	
Hardness HB max.	—	187	—	185	187	187	217	
Parts	Body, bonnet, yoke				Stem, post		Knife	

NOTICE

1. Knife Gate valves should preferably not be opened or closed against pressure.
2. Lugs should not be used to adjust misalignment in piping.
3. Velan reserves the right to take exception to warranty when misapplications / 3rd party automation and other operations are carried out without Velan's prior knowledge.
4. Consult Velan sales for standard factory warranty.

THE MOST COMPREHENSIVE LINE OF INDUSTRIAL FORGED AND CAST STEEL GATE, GLOBE, CHECK, BALL, BUTTERFLY AND KNIFE GATE VALVES

ASME Pressure Classes 150–4500 in Carbon, Alloy and Stainless Steel

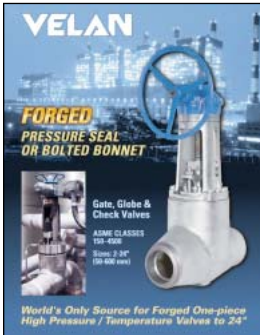

VEL-PS

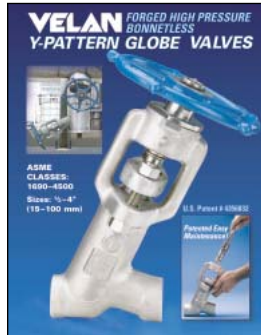

VEL-BG

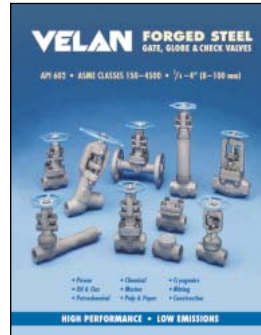

VEL-SFV

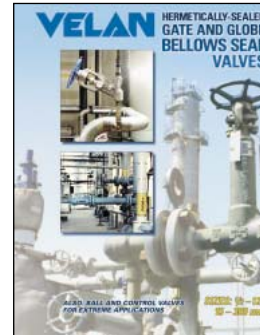

VEL-BS

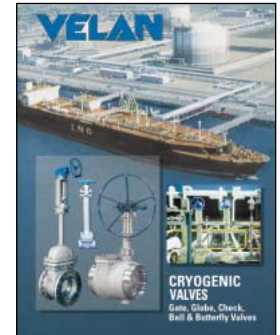

VEL-CRYO

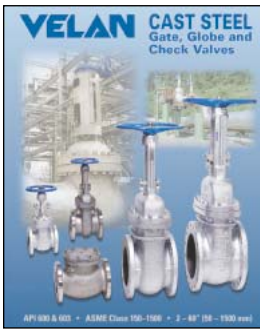

VEL-API-603

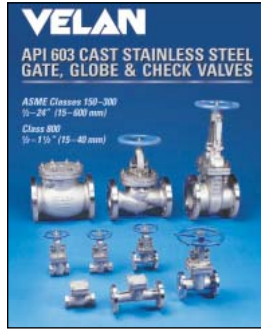

VEL-KGV

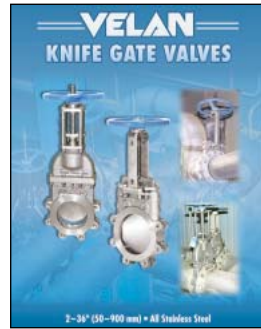

VEL-PRO-CV

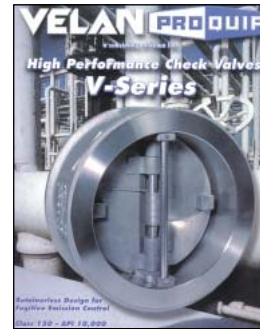

VEL-ADCV

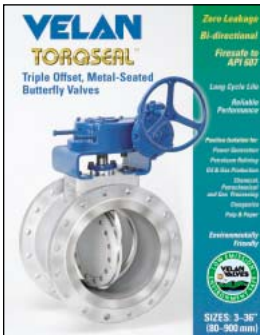

VEL-BF



VEL-MS

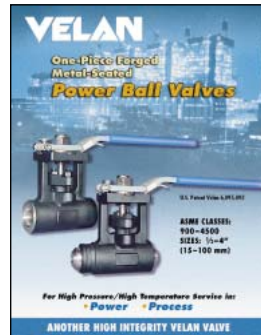

VEL-PBV

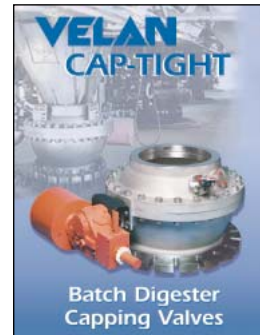

VEL-BDC

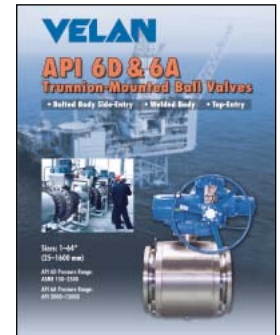

VEL-BV6D

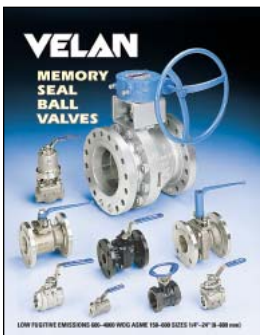

VEL-BV



VEL-UB

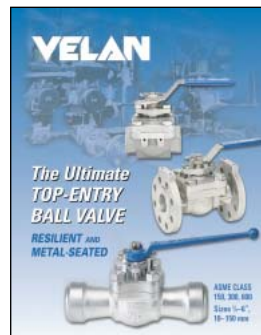

VEL-TE

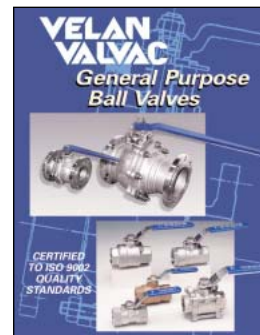

VEL-GP2BV

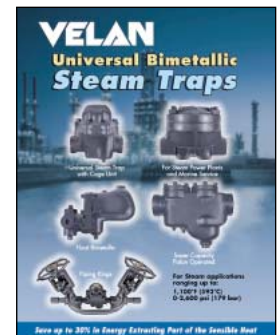

VEL-ST